

NICOLock[®]

PAVING STONES • RETAINING WALLS • OUTDOOR LIVING

paver-shield[™]

NEW HAVEN
MASONRY
& BUILDING SUPPLY, INC.
203-562-6657

IN-STOCK COLLECTION



Granite City Blend
Stone Ridge

PAVING STONES & RETAINING WALLS



Stone Ridge Collection



Multi-sized rectangular shapes. Slightly textured riven surface. Slightly chamfered edge. Stone Ridge and Stone Ridge XL can be combined. Stone Ridge XL not recommended for vehicular applications.

Stone Ridge

	WIDTH	LENGTH	THICKNESS	PCS/SF	SF/PALLET	PCS/PALLET	LBS/PALLET
A	4 1/2"	9"	23/8"	3.8		130	
B	9"	9"	23/8"	1.9	110	60	2,950
C	9"	13 1/2"	23/8"	1.3		50	



Stone Ridge XL

	WIDTH	LENGTH	THICKNESS	PCS/SF	SF/PALLET	PCS/PALLET	LBS/PALLET
A	9"	9"	23/8"	1.9		20	
B	9"	18"	23/8"	.93	110	50	2,950
C	18"	18"	23/8"	.46		20	



Sizes not sold separately



GRANITE CITY BLEND OCEANIC BLUE* SOUTH BAY BLEND* WESTCHESTER BLEND

*Premium Color
 paver-shield™

Rustico 6x9



Single-sized square and rectangular shapes with a slightly dimpled surface. Chamfered edges and square corners make these perfect for inlays and borders.

	WIDTH	LENGTH	THICKNESS	PCS/SF	SF/PALLET	PCS/PALLET	LBS/PALLET
A	6"	9"	2 3/8"	3	113	300	2,982

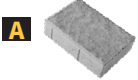

*Premium Color
 paver-shield™



ADOBE BLEND CHARCOAL GRANITE CITY BLEND MARBLE BLEND* RAVEN*

Alta Wall & Alta Pro Wall



The Alta and Alta Pro Walls are versatile walls for everyday landscape applications. Their tapered designs simplify installation of inside and outside curves so you can design with freedom. The hollow core design and rear lip connection make these wall systems a go-to system for professionals.

	HEIGHT	WIDTH	DEPTH	PCS/SF SF/PALLET	PCS/PALLET	LBS/PALLET	
A	6"	16"	12"	1.5	26.6	40	1,962
B	8"	18"	12"	1	40	40	2,404

Sizes sold separately



ADOBE BLEND



GRANITE CITY BLEND



WESTCHESTER BLEND
(ALTA ONLY)

6" Colonial Wall



The Colonial Wall System features a distinctive double-sided face, hard-split finish. You can build the 3" or 6" wall individually or combine them for added dimension. There is also a prepackaged Colonial Pier to add the finishing touch to your wall.

	HEIGHT	WIDTH	DEPTH	SF/PALLET	PCS/PALLET	LBS/PALLET
A	6"	16"	9"			15
B	6"	12"	9"			25
C	6"	9"	9"	35		25
D	6"	16"	9"			10

Sizes not sold separately



ADOBE BLEND



GRANITE CITY BLEND



SOUTH BAY BLEND

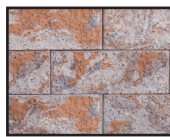

WESTCHESTER BLEND



Granite City Blend

TECHO — BLOC

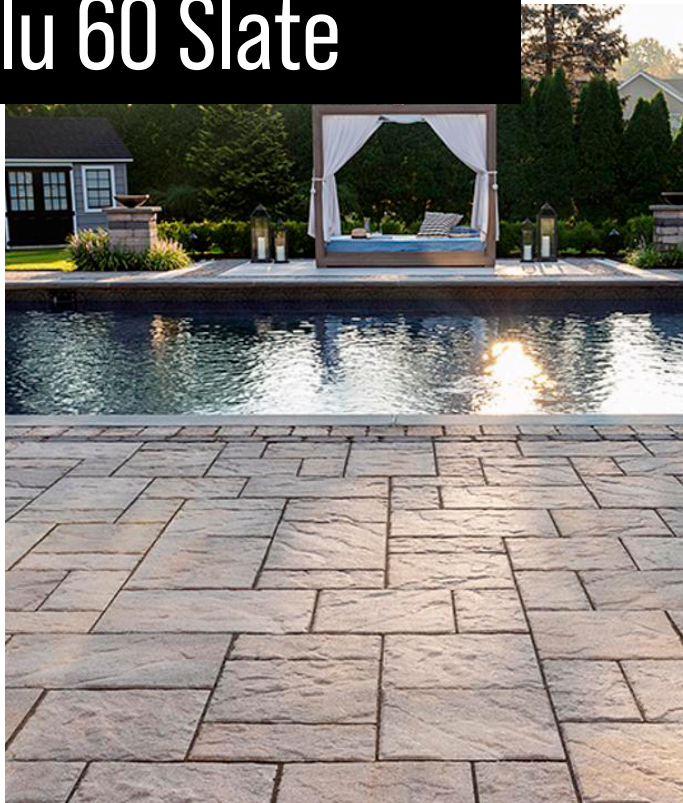
Blu 60 Slate



The best-selling Blu slate patio slab was inspired by natural slate stone. This traditional patio stone comes in multiple sizes for your backyard pool decks, patios & walkways. The same lines and rugged texture as our thicker Blu paver, the same opulent colors and traditional look, Blu 60 Slate slab is the choice for pedestrian areas such as on walkways and patios.

Specifications per pallet:		Imperial
A		Product dimension (L x W x H) A 6 1/2 x 13 x 2 3/8
	44 units / pallet	Product dimension (L x W x H) B 13 x 13 x 2 3/8
		Product dimension (L x W x H) C 19 1/2 x 13 x 2 3/8
B		Cubing 116.82 ft ²
	44 units / pallet	Approx. Weight slate 3 148 lbs
		Approx. Weight HD ₂ Slate 3 268 lbs
C		Number of rows 11
	22 units / pallet	Coverage per row 10.62 ft ²
		Lin. coverage per row 9.81 lin. ft

Available In

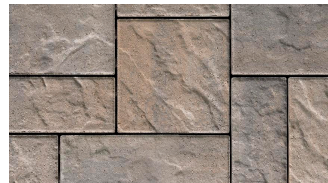



Champlain Grey



Shale Grey

Chiseled and sculpted, Eva Slate entertains its onlookers with its unique slate/flagstone surface texture. Alongside the paver's petite dimensions that make for fast and easy installation, its proportions also allow for a modular or linear interlocking patterns. Not only does Eva Slate's appearance bring a new perspective to traditional-looking patio pavers at a budget-friendly price, but the pavement is also de-icing salt-resistant, withstands harsh climates and comes with a transferable lifetime warranty. Achieve the perfect landscape design with the Eva Slate paver. Great for driveways, walkways, pool decks and patios. Vehicular and pedestrian friendly.

Specifications per pallet		Imperial
A		Product dimension (L x W x H) A 4 3/8 x 8 3/4 x 2 3/8
	132 units / pallet	Product dimension (L x W x H) B 8 3/4 x 8 3/4 x 2 3/8
		Product dimension (L x W x H) C 13 3/16 x 8 3/4 x 2 3/8
B		Cubing 132.48 ft ²
	99 units / pallet	Approx. Weight 3 643 lbs
		Number of rows 11
C		Coverage per row 12.04 ft ²
	55 units / pallet	Lin. coverage per row 16.46 lin. ft

Available In

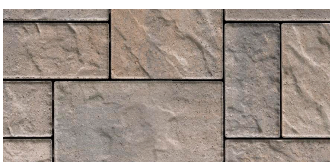

Champlain Grey

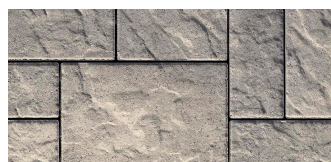

Shale Grey

Eva Slate

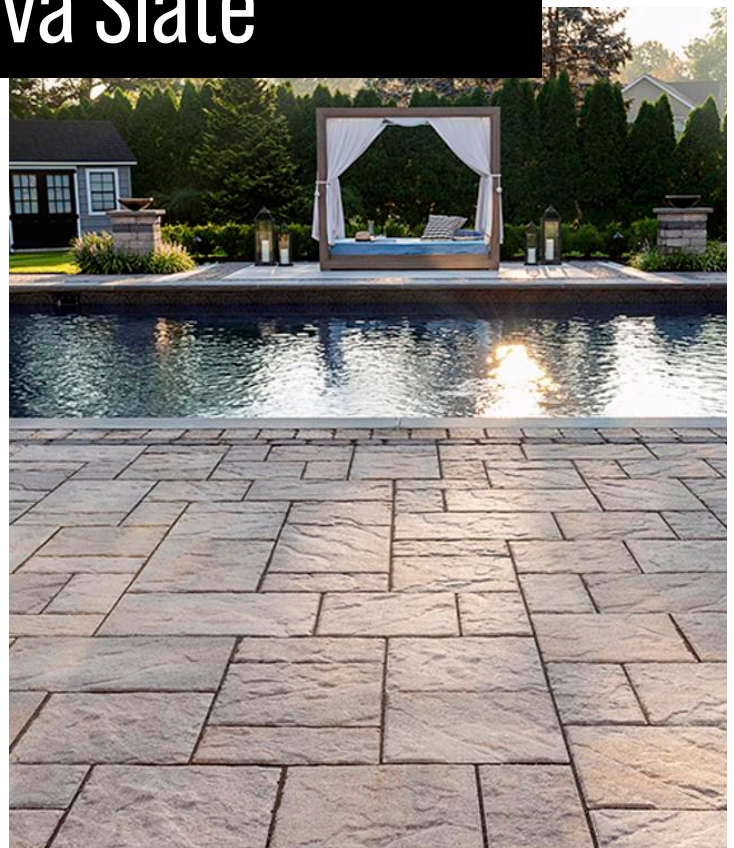

TECHO — BLOC

Mini Creta 6" & 3"

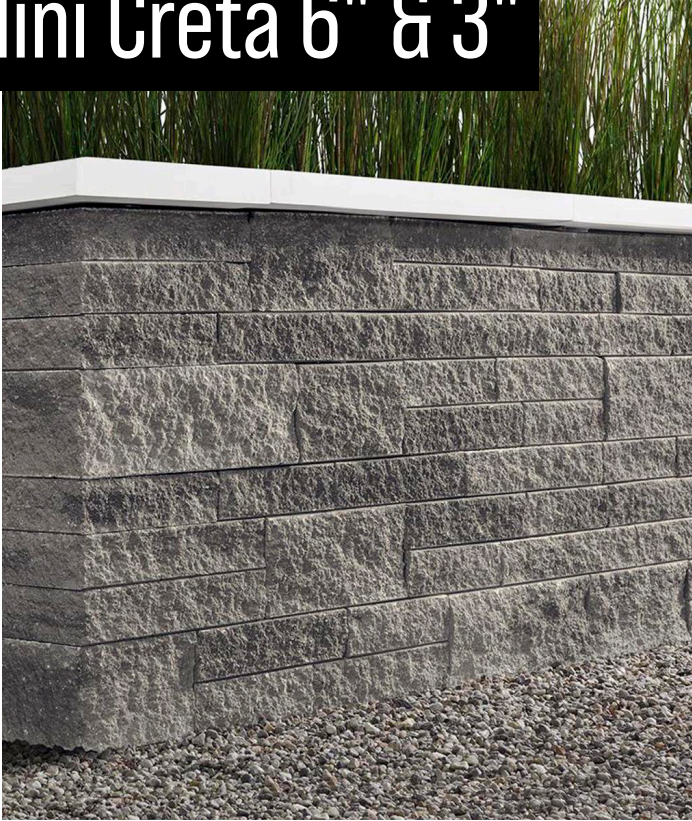

Mini-Creta Architectural retaining wall has earned its name due to its modern twist on the traditional Mini-Creta wall. This new wall boasts brighter colors, sleeker lines and sharper corners to give an overall contemporary stone look to garden walls, outdoor kitchens and bars. Mini-Creta Architectural is the perfect choice for a retaining wall, outdoor kitchens, outdoor fire features and is also available as a Pillar kit.

Specifications per pallet: 6" MINI CRETA

Cubing	30 ft ²
	59.38 lin. ft
Approx. Weight	3 086lbs
Minimum radius	7 ft
Number of rows	5
Coverage per row	6 ft ²
Lin. coverage per row	11.88 lin. ft

Available In



Champlain Grey
Split face
straight edged
corners

Specifications per pallet: 3" MINI CRETA

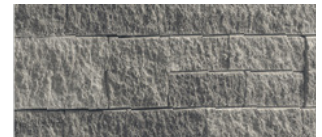

Cubing	24 ft ²
	95.01 lin. ft
Approx. Weight	2 465 lbs
Minimum radius	7 ft
Number of rows	8
Coverage per row	3 ft ²
Lin. coverage per row	11.88 lin. ft



Shale Grey
Split face
straight edged
corners

A 6" x 16" double-sided segmental retaining wall, with tapered sides and an independent mechanical interlock, allowing for a vertical or battered wall. Semma also has tremendous shear strength (block to block contact), void fill interlock (4 cored system with contractor gravel-filled cores), and a 1/2" bond for joint dispersion. Semma wall, with an integrated Coin on every layer, makes a great solution to the raised patio quandary: building a structural wall and topping it with a parapet (free-standing wall). Use the Semma pillars to finish or add drama or light features to your wall. Polished finish only available in Canada. Semma is part of the dry cast collection.

Specifications per pallet

	Imperial
A 	Dimension Front (L x D x H) A 16 x 11 x 5 7/8
	Dimension Back (L x D x H) A 10 1/2 x 11 x 5 7/8
	Dimension Front (L x D x H) B 16 x 11 x 5 7/8
B 	Dimension Back (L x D x H) B 10 1/2 x 11 x 5 7/8
	40 units
	Cubing 26.25 ft ²
	53.33 lin. ft
	Approx. Weight 2 363 lbs
	Number of rows 5
	Coverage per row 5.25 ft ²
	Lin. coverage per row 10.67 lin. ft

Semma Wall



Available In

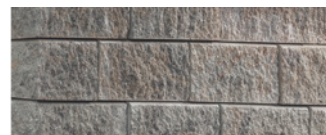

Champlain Grey







Shale Grey

TECHO — BLOC

Villagio



Inspired by Montreal's beautiful century-old streets, refine your backyard with the Villagio paver. Offering versatile backyard designs, Villagio can easily be the main-field of focus in your beautiful outdoor living space. Moreover, the paver's beveled texture and multiple dimensions allows you to easily install curved, decorative bandings in your backyard with all 57 mm & 60 mm of Stonedge and Techo-Bloc slab collections.

Specifications per pallet		Imperial
A  77 units / pallet	Product dimension (L×W×H)	5 1/8 × 5 1/8 × 2 3/8
	Product dimension (L×W×H)	6 5/16 × 5 1/8 × 2 3/8
B  77 units / pallet	Product dimension (L×W×H)	7 5/16 × 5 1/8 × 2 3/8
	Product dimension (L×W×H)	8 7/16 × 5 1/8 × 2 3/8
C  154 units / pallet	Cubing	117 ft ²
	Approx. Weight	2 960 lbs
D  154 units / pallet	Number of rows	11
	Coverage per row	10.64 ft ²
Lin. coverage per row		24.94 lin. ft

Available In



Champlain Grey



Shale Grey



Onyx

Our Valet pavers are a great way to add character and a touch of luxury to any driveway. These 6 1/2 by 6 1/2 inch square shaped units were inspired by lava rock/basalt stone, the highly textured surface of the Valet paver brings added visual interest to bandings, mosaics and complete pavements with the same salt-resistant qualities you expect of Techo-Bloc's dry cast line.

Specifications per pallet		Imperial
 315 units / pallet	Product dimension (L×W×H)	6 1/2 × 6 1/2 × 2 3/8
	Cubing	92.31 ft ²
	Approx. Weight	2 381 lbs
	Number of rows	9
	Coverage per unit	10.26 ft ²
Lin. coverage per row		18.95 lin. ft

Available In

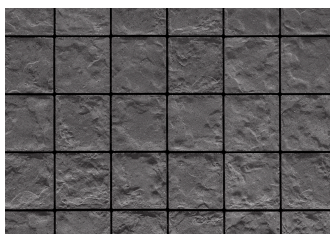

Onyx

Valet

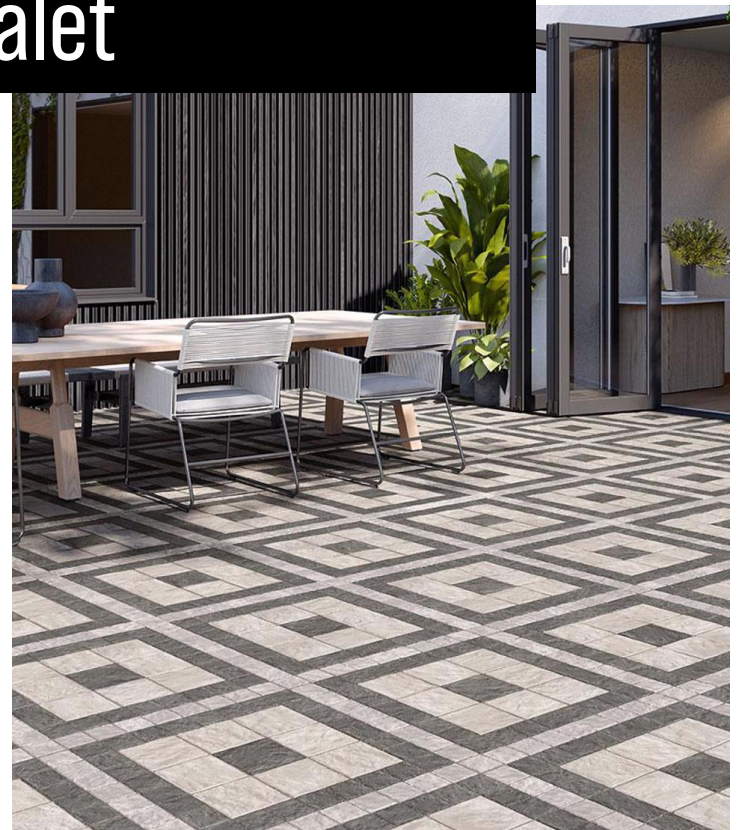

Natural Stone Treads, Pavers & Edging

Bluestone



Available in

- 1.5" & 2" Tread Stock
- 1" & 1.5" Feild

Full Color Bluestone



Available in

- 2" Tread Stock
- 1.5" Feild

Nat. Cleff Full Color



Available in

- 1.5" Feild

Brownstone



Available in

- 2" Tread Stock
- 1.25" Feild

Salt & Pepper Granite



Available in

- 2" Tread Stock
- 1" Feild

Dark Granite



Available in

- 2" Tread(s)
- 1" Field

Caribbean Blue



Available in

- 2" Tread Stock
- 1.25" Feild

Grey Cobblestone



Available in

- 4" x 7" x 10" Jumbo
- 5" x 5" x 9" Regulation
- 4" x 4" x 8" Landscape

Black Cobblestone

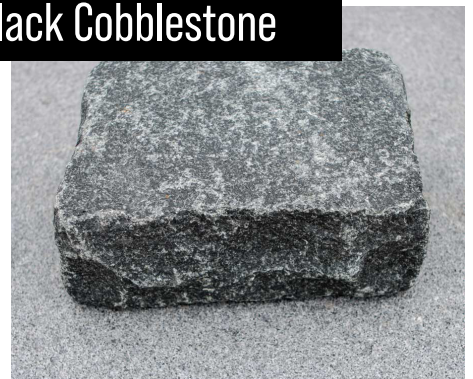

Available in

- 4" x 7" x 10" Jumbo2

Veneer Stone - Instock

Dutch Blend Mosaic



Available in

- 1.5" & 2" Tread Stock
- 1" & 1.5" Feild

Chester Ashlar



Available in

- 2" Tread Stock
- 1.5" Feild

Chester Ledge

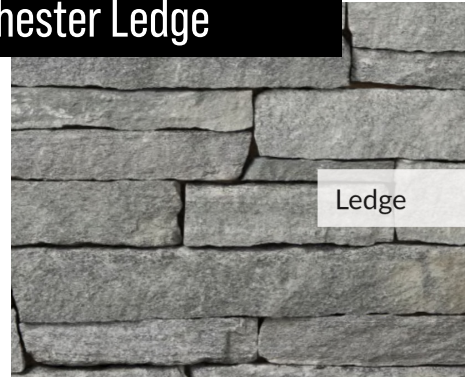

Available in

- 1.5" Feild

West Coast Ledge



Available in

- 2" Tread Stock
- 1.25" Feild

New England Panel



Available in

- 2" Tread Stock
- 1" Feild

Berkshire Panel



Available in

- 2" Tread(s)
- 1" Field

NICOLOCK[®]

PAVING STONES • RETAINING WALLS • OUTDOOR LIVING



WITHOUT
Nicolock paver-shield™

Nicolock has color from top to bottom throughout the paver ensuring a lifetime of beauty.

Iron oxide pigments are **GUARANTEED** to last for generations!



WITH
Nicolock paver-shield™

IN-Stock Benefit

You'll have full confidence with our IN-Stock products for anything you need to finish your project worry free. Whether you're designing, bidding, or installing, New Haven Masonry will have what you need.

IN STOCK
PRODUCTS

ORDER-IN
PRODUCTS

Order-IN Program

For all other products featured in the Nicolock Catalog, take advantage of our Order-IN Program and have them delivered quickly. See associate for details.

New Haven Masonry
355 James St New
Haven, CT 06513
(203) 562-6657
www.newhavenmasonrysupply.com

NOTE: We have made every effort to represent the color of the product accurately in our marketing materials and on our website. Final selection of colors should be made from several physical samples. Shade variations are inherent in colored concrete products using natural materials. Delivered product can vary slightly from physical samples.